

Supplementary Information

Development of Three-Dimensional Electrodes of PbO₂ Electrodeposited on Reticulated Vitreous Carbon for Organic Electrooxidation

*Rosimeire M. Farinos, Rafael L. Zornitta and Luís A. M. Ruotolo**

*Departamento de Engenharia Química, Universidade Federal de São Carlos, P.O. Box 676,
13565-905 São Carlos-SP, Brazil*



Figure S1. RVC substrate (45 ppi, 0.5 × 2.5 × 2.5 cm).

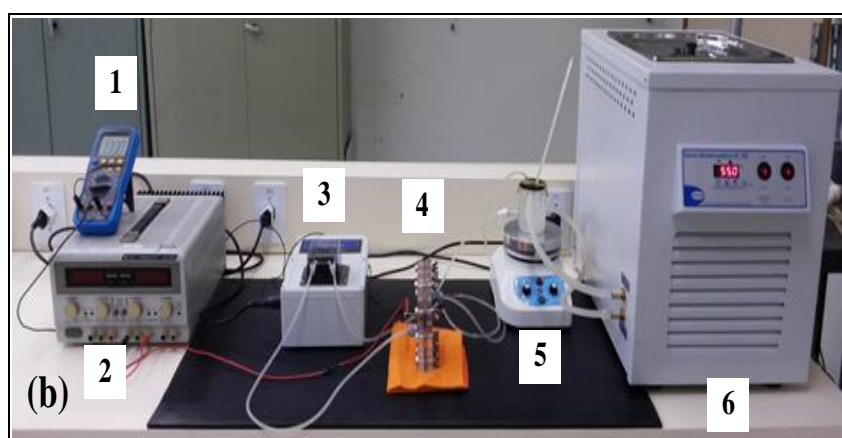
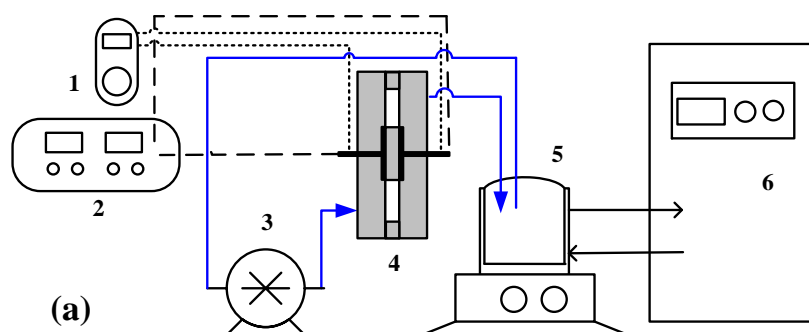

Figure S2. (a) Schematic representation and (b) photograph of the experimental system. (1) Multimeter; (2) current source; (3) peristaltic pump; (4) electrochemical reactor; (5) electrolyte reservoir and magnetic stirrer; (6) thermostatic bath.

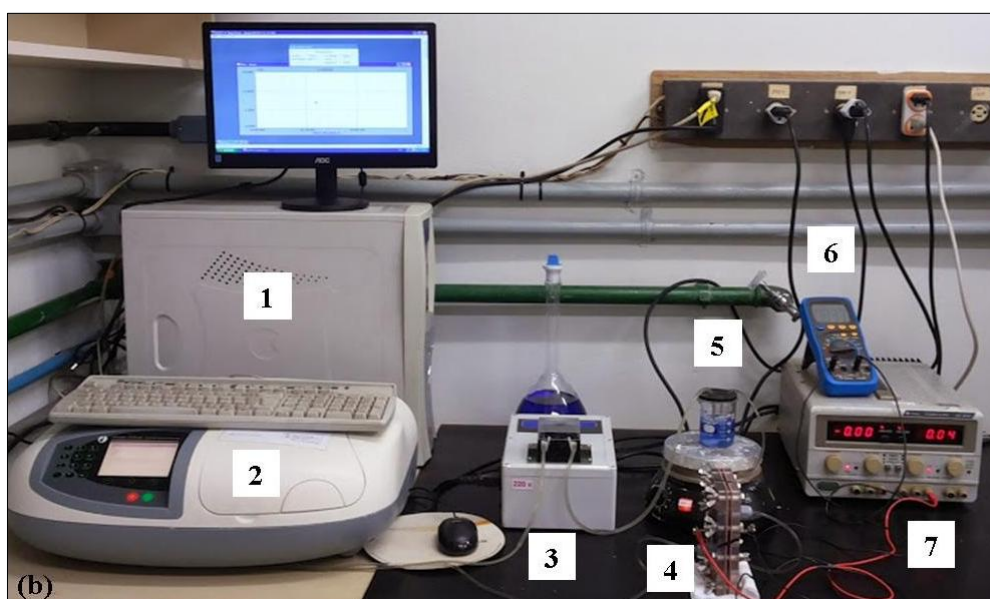
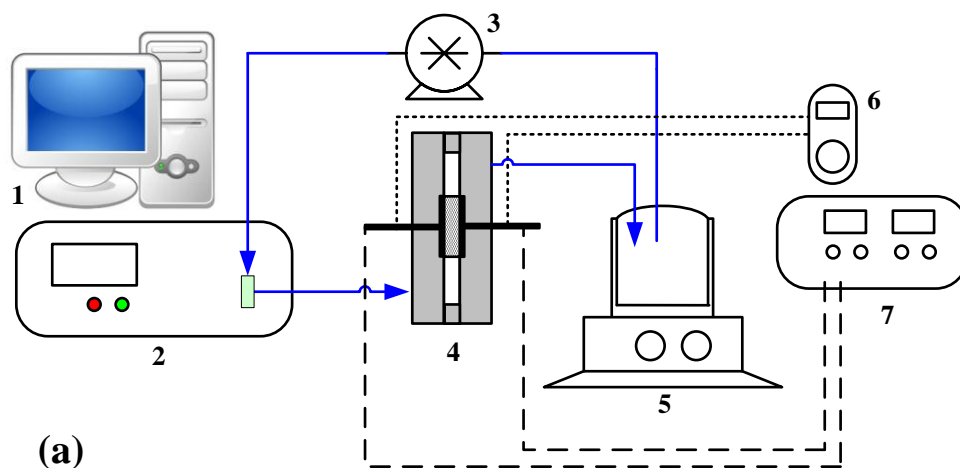

Figure S3. (a) Schematic representation and (b) photograph of the experimental device used in the dye decoloration experiments. (1) Computer; (2) UV-Vis spectrophotometer; (3) peristaltic pump; (4) electrochemical reactor; (5) electrolyte reservoir; (6) multimeter; (7) current source.



Figure S4. Photograph of the electrochemical reactor.

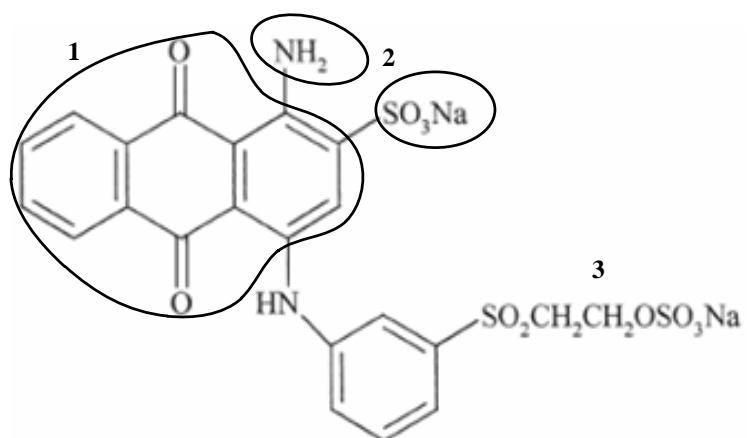

Figure S5. Structure of the RB 19 dye. (1) Chromophore group responsible for the color; (2) auxochromes (electron donor or acceptor substituents), and (3) the structure responsible for fixing in fibers.

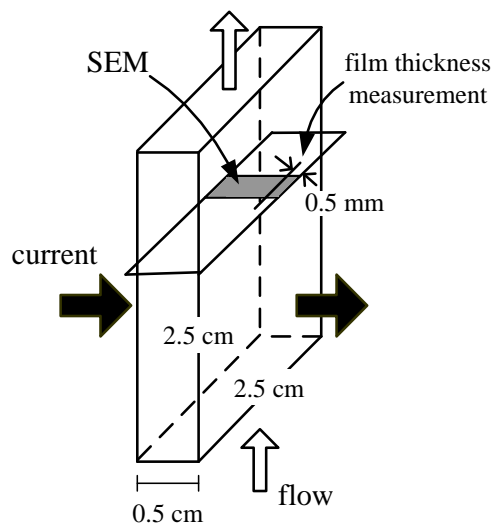
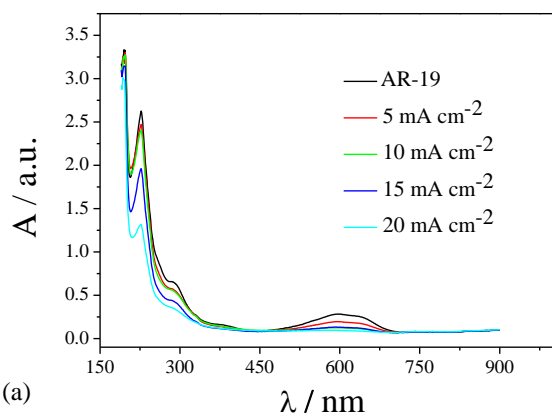

Figure S6. Schematic representation of the surface of the RVC/PbO₂ electrode analyzed by SEM.



(a)



(b)

Figure S7. (a) UV-Vis absorbance spectra and (b) photograph of the initial and final RB 19 dye solutions according to the different applied current densities. Electrode: RVC/PbO₂-2; $C_0 = 30 \text{ mg L}^{-1}$; supporting electrolyte: $0.5 \text{ mol L}^{-1} \text{ Na}_2\text{SO}_4$; flow rate: 30 mL min^{-1} .